

MIW5000 Series

10W, Wide Input Range DIP, Single & Dual Output DC/DC Converters

Key Features

- High Efficiency up to 88%
- 1500VDC Isolation
- MTBF > 1,000,000 Hours
- 2:1 Wide Input Range
- CSA1950 Safety Approval
- Complies with EN55022 Class A
- Over Voltage Protection
- Industry Standard Pinout
- UL 94V-0 Package Material
- Internal SMD Construction



Minmax's MIW5000-Series power modules operate over input voltage ranges of 9–18VDC, 18–36VDC and 36–75VDC which provide precisely regulated output voltages of 2.5V, 3.3V, 5V, 5.1V, 12V, 15V, $\pm 12V$ and $\pm 15VDC$.

The MIW5000 series is an excellent selection for data communication equipments, mobile battery driven equipments, distributed power systems, telecommunication equipments, mixed analog/digital subsystems, process/machine control equipments, computer peripheral systems and industrial robot systems.

The modules have a maximum power rating of 10W and a typical full-load efficiency of 88%, continuous short circuit, 50mA output ripple, EN55022 Class A conducted noise compliance minimize design-in time, cost and eliminate the need for external filtering.

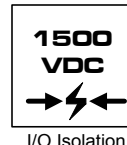
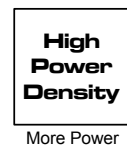

Block Diagram

Single Output

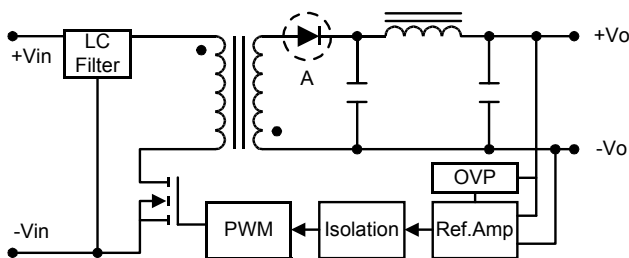

Dual Output

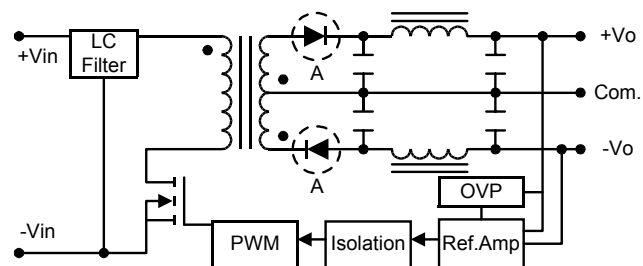

A: 2.5V, 3.3V, 5V and 5.1V-output models use the synchronous-rectifier configuration shown above.
12V, 15V, $\pm 12V$ and $\pm 15V$ -output models employ a standard, diode-rectification architecture.

Model Selection Guide

Model Number	Input Voltage	Output Voltage	Output Current		Input Current		Reflected Ripple Current	Efficiency
			Max.	Min.	@Max. Load	@No Load		@Max. Load
	VDC	VDC	mA	mA	mA (Typ.)	mA (Typ.)	mA (Typ.)	% (Typ.)
MIW5021	12 (9 ~ 18)	3.3	3000	300	1006	40	60	82
MIW5022		5	2000	200	1004			83
MIW5023		12	833	83	957			87
MIW5024		15	666	66.6	968			86
MIW5026		±12	±416	±42	957			87
MIW5027		±15	±333	±33	968			86
MIW5029		5.1	2000	200	1024			83
MIW5030	24 (18 ~ 36)	2.5	3000	300	377	20	40	83
MIW5031		3.3	3000	300	485			85
MIW5032		5	2000	200	479			87
MIW5033		12	833	83	479			87
MIW5034		15	666	66.6	478			87
MIW5036		±12	±416	±42	473			88
MIW5037		±15	±333	±33	478			87
MIW5039		5.1	2000	200	489			87
MIW5040	48 (36 ~ 75)	2.5	3000	300	188	10	40	83
MIW5041		3.3	3000	300	243			85
MIW5042		5	2000	200	239			87
MIW5043		12	833	83	240			87
MIW5044		15	666	66.6	239			87
MIW5046		±12	±416	±42	236			88
MIW5047		±15	±333	±33	243			87
MIW5049		5.1	2000	200	244			87

Absolute Maximum Ratings

Parameter	Min.	Max.	Unit	
Input Surge Voltage (1000 mS)	12VDC Input Models	-0.7	25	VDC
	24VDC Input Models	-0.7	50	VDC
	48VDC Input Models	-0.7	100	VDC
Lead Temperature (1.5mm from case for 10 Sec.)	---	260	°C	
Internal Power Dissipation	---	2,500	mW	

Exceeding the absolute maximum ratings of the unit could cause damage. These are not continuous operating ratings.

Environmental Specifications

Parameter	Conditions	Min.	Max.	Unit
Operating Temperature	Ambient	-40	+60	°C
Operating Temperature	Case	-40	+90	°C
Storage Temperature		-40	+125	°C
Humidity		---	95	%
Cooling	Free-Air Convection			
Conducted EMI	EN55022 Class A			

Notes :

- Specifications typical at $T_a=+25^{\circ}\text{C}$, resistive load, nominal input voltage, rated output current unless otherwise noted.
- Transient recovery time is measured to within 1% error band for a step change in output load of 75% to 100%.
- Ripple & Noise measurement bandwidth is 0-20 MHz.
- These power converters require a minimum output loading to maintain specified regulation.
- Operation under no-load conditions will not damage these modules; however, they may not meet all specifications listed.
- All DC/DC converters should be externally fused on the front end for protection.
- Other input and output voltage may be available, please contact factory.
- Specifications subject to change without notice.

Input Specifications

Parameter	Model	Min.	Typ.	Max.	Unit
Start Voltage	12V Input Models	7	8	9	VDC
	24V Input Models	14	16	18	
	48V Input Models	30	33	36	
Under Voltage Shutdown	12V Input Models	---	---	8.5	
	24V Input Models	---	---	17	
	48V Input Models	---	---	34	
Reverse Polarity Input Current	All Models	---	---	0.5	A
Short Circuit Input Power		---	---	2500	mW
Input Filter		Pi Filter			

Output Specifications

Parameter	Conditions	Min.	Typ.	Max.	Unit
Output Voltage Accuracy		---	± 0.6	± 1.2	%
Output Voltage Balance	Dual Output, Balanced Loads	---	± 0.5	± 2.0	%
Line Regulation	$V_{in} = \text{Min. to Max.}$	---	± 0.3	± 1.0	%
Load Regulation	$I_o = 10\% \text{ to } 100\%$	---	± 0.5	± 1.2	%
Load Regulation	$I_o = 10\% \text{ to } 100\% \text{ (only } 2.5V_{out})$	---	± 0.7	± 1.5	%
Ripple & Noise (20MHz)		---	50	85	mV P-P
Ripple & Noise (20MHz)	Over Line, Load & Temp.	---	---	100	mV P-P
Ripple & Noise (20MHz)		---	---	15	mV rms
Over Power Protection		110	150	180	%
Transient Recovery Time	25% Load Step Change	---	250	500	μs
Transient Response Deviation		---	± 3	± 5	%
Temperature Coefficient		---	± 0.01	± 0.02	%/°C
Output Short Circuit	Continuous				

General Specifications

Parameter	Conditions	Min.	Typ.	Max.	Unit
Isolation Voltage Rated	60 Seconds	1500	---	---	VDC
Isolation Voltage Test	Flash Tested for 1 Second	1650	---	---	VDC
Isolation Resistance	500VDC	1000	---	---	M Ω
Isolation Capacitance	100KHz, 1V	---	1000	1200	pF
Switching Frequency		---	400	---	KHz
MTBF	MIL-HDBK-217F @ 25°C, Ground Benign	1000	---	---	K Hours

Capacitive Load

Models by Vout	2.5V	3.3V	5V	5.1V	12V	15V	$\pm 12V \#$	$\pm 15V \#$	Unit
Maximum Capacitive Load	2200	2200	2200	2200	820	470	220	150	μF

For each output

Input Fuse Selection Guide

12V Input Models	24V Input Models	48V Input Models
2000mA Slow-Blow type	1000mA Slow-Blow type	500mA Slow-Blow type

Input Voltage Transient Rating

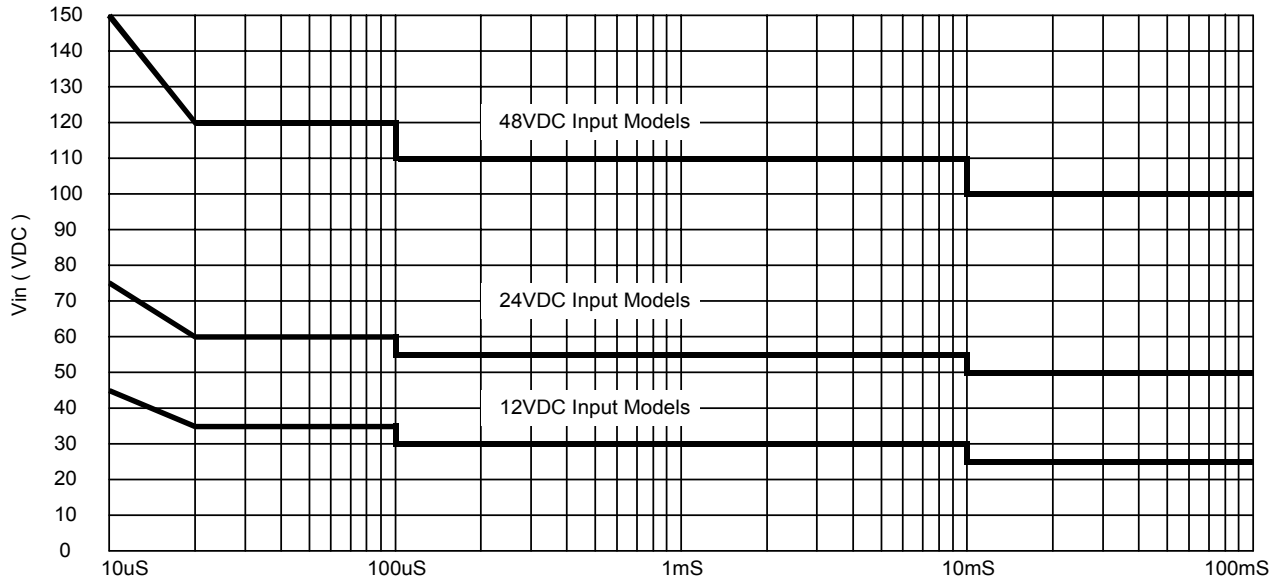

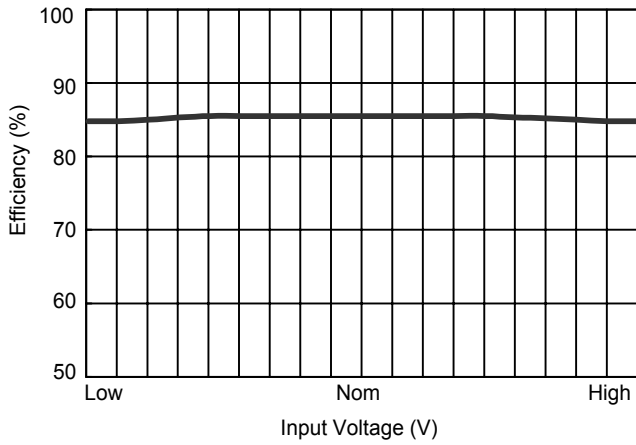

Efficiency vs Input Voltage (Single Output)

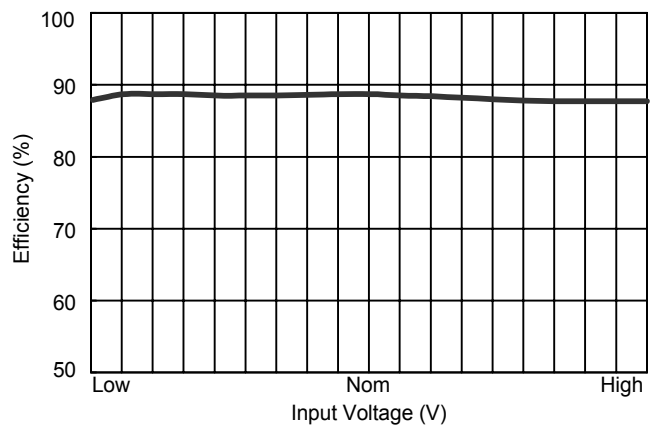

Efficiency vs Input Voltage (Dual Output)

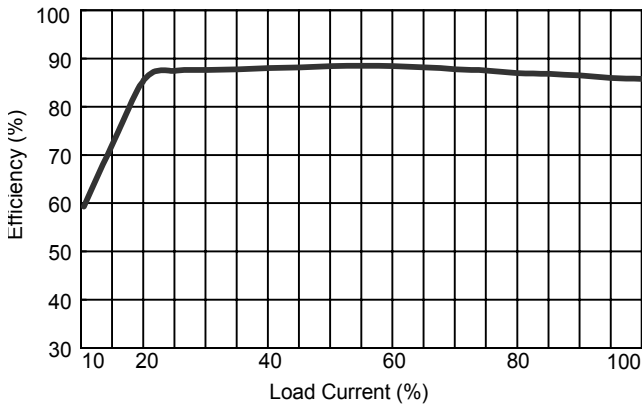

Efficiency vs Output Load (Single Output)

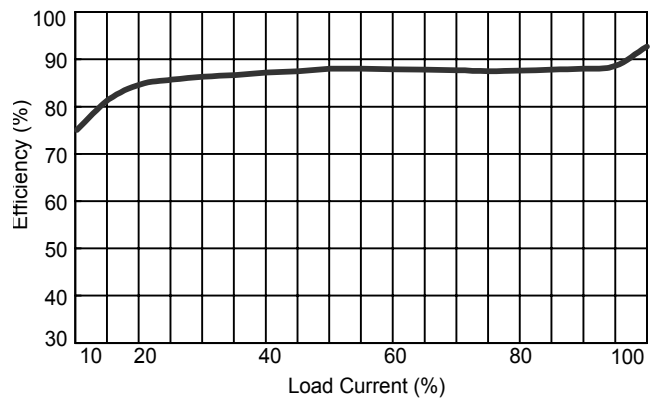

Efficiency vs Output Load (Dual Output)

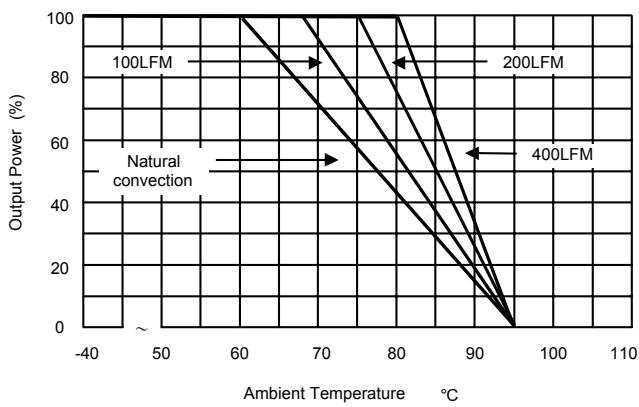

Derating Curve

Test Configurations

Input Reflected-Ripple Current Test Setup

Input reflected-ripple current is measured with an inductor L_{in} (4.7uH) and C_{in} (220uF, ESR < 1.0Ω at 100 kHz) to simulated source impedance.

Capacitor C_{in} , offsets possible battery impedance.

Current ripple is measured at the input terminals of the module, measurement bandwidth is 0–500KHz.

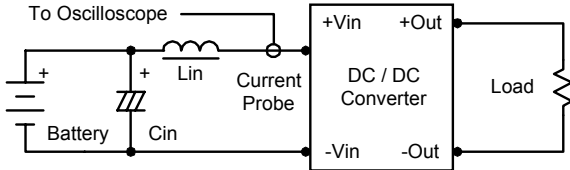

Peak-to-Peak Output Noise Measurement Test

Use a C_{out} 0.47uF ceramic capacitor.

Scope measurement should be made by using a BNC socket, measurement bandwidth is 0–20 MHz. Position the load between 50 mm and 75 mm from the DC/DC Converter.

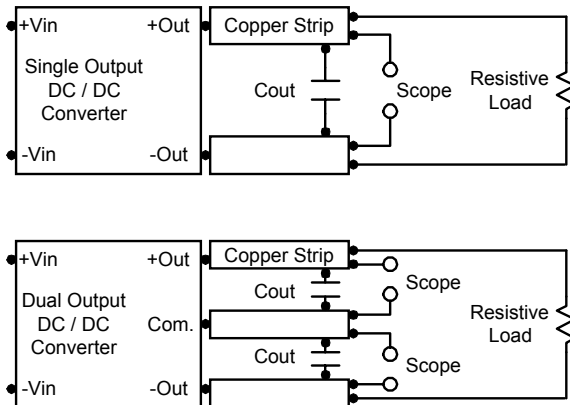

Design & Feature Considerations

Maximum Capacitive Load

The MIW5000 series has limitation of maximum connected capacitance on the output.

The power module may operate in current limiting mode during start-up, affecting the ramp-up and the startup time.

The maximum capacitance can be found in the data sheet.

Overcurrent Protection

To provide protection in a fault (output overload) condition, the unit is equipped with internal current limiting circuitry and can endure current limiting for an unlimited duration. At the point of current-limit inception, the unit shifts from voltage

control to current control. The unit operates normally once the output current is brought back into its specified range.

Overvoltage Protection

The output overvoltage clamp consists of control circuitry, which is independent of the primary regulation loop, that monitors the voltage on the output terminals.

The control loop of the clamp has a higher voltage set point than the primary loop.

This provides a redundant voltage control that reduces the risk of output overvoltage.

Input Source Impedance

The power module should be connected to a low ac-impedance input source. Highly inductive source impedances can affect the stability of the power module.

In applications where power is supplied over long lines and output loading is high, it may be necessary to use a capacitor on the input to insure startup.

By using a good quality low Equivalent Series Resistance (ESR < 1.0Ω at 100 kHz) capacitor of a 12uF for the 12V, 4.7uF for the 24V input devices and a 2.2uF for the 48V devices, capacitor mounted close to the power module helps ensure stability of the unit.

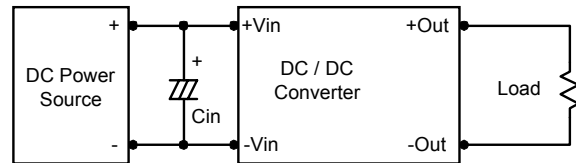

Output Ripple Reduction

A good quality low ESR capacitor placed as close as practicable across the load will give the best ripple and noise performance.

To reduce output ripple, it is recommended that 3.3uF capacitors are used on output.

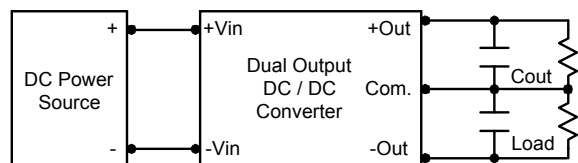
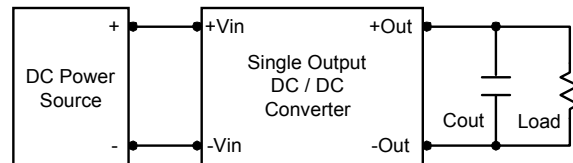

Thermal Considerations

Many conditions affect the thermal performance of the power module, such as orientation, airflow over the module, and board spacing. To avoid exceeding the maximum temperature rating of the components inside the power module, the case temperature must be kept below 95°C.

The derating curves were determined from measurements obtained in an experimental apparatus.

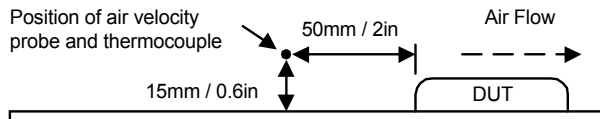

Mechanical Dimensions

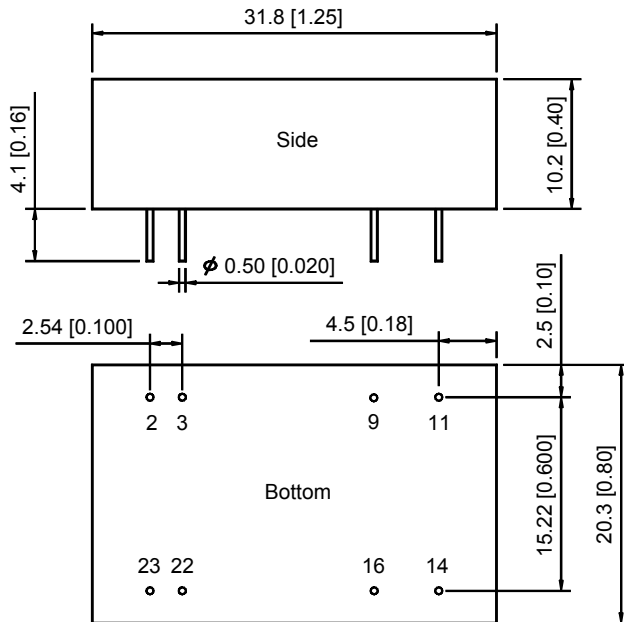

Tolerance	Millimeters	Inches
	X.X±0.25	X.XX±0.01
	X.XX±0.13	X.XXX±0.005
Pin	±0.05	±0.002

Connecting Pin Patterns

Top View (2.54 mm / 0.1 inch grids)

Single Output

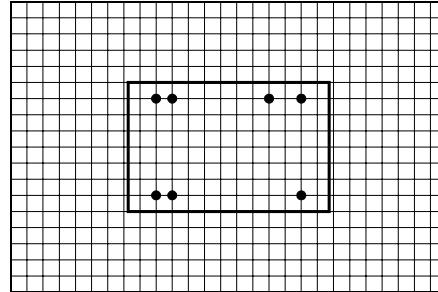

Dual Output

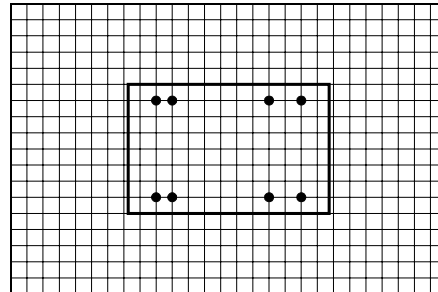

Pin Connections

Pin	Single Output	Dual Output
2	-Vin	-Vin
3	-Vin	-Vin
9	No Pin	Common
11	NC	-Vout
14	+Vout	+Vout
16	-Vout	Common
22	+Vin	+Vin
23	+Vin	+Vin

NC: No Connection

Physical Characteristics

Case Size	: 31.8×20.3×10.2 mm 1.25×0.80×0.40 inches
Case Material	: Metal With Non-Conductive Baseplate
Weight	: 17.3g
Flammability	: UL94V-0

The MIW5000 converter is encapsulated in a low thermal resistance molding compound that has excellent resistance/electrical characteristics over a wide temperature range or in high humidity environments. The encapsulant and unit case are both rated to UL 94V-0 flammability specifications. Leads are tin plated for improved solderability.